

Automating Material Composition Reporting with RosettaNet

Seigo ITO

e-Business Creation Dept.,
Semiconductor Company,
Toshiba Corporation

Chair,
ELCI (Environmental Life Cycle Information) -WG,
RosettaNet Japan

December 8, 2005

seigo2.ito@toshiba.co.jp

Agenda

Today's presentation

1. RosettaNet

2. Material Composition Milestone Program

3. Declaration Format

4. Activity of RosettaNet Japan (RNJ)

- ELCI (Environmental Life Cycle Information) -WG
- EIM (Engineering Information Management) -WG

5. Summary

RosettaNet

Develop & Promote B2B standards

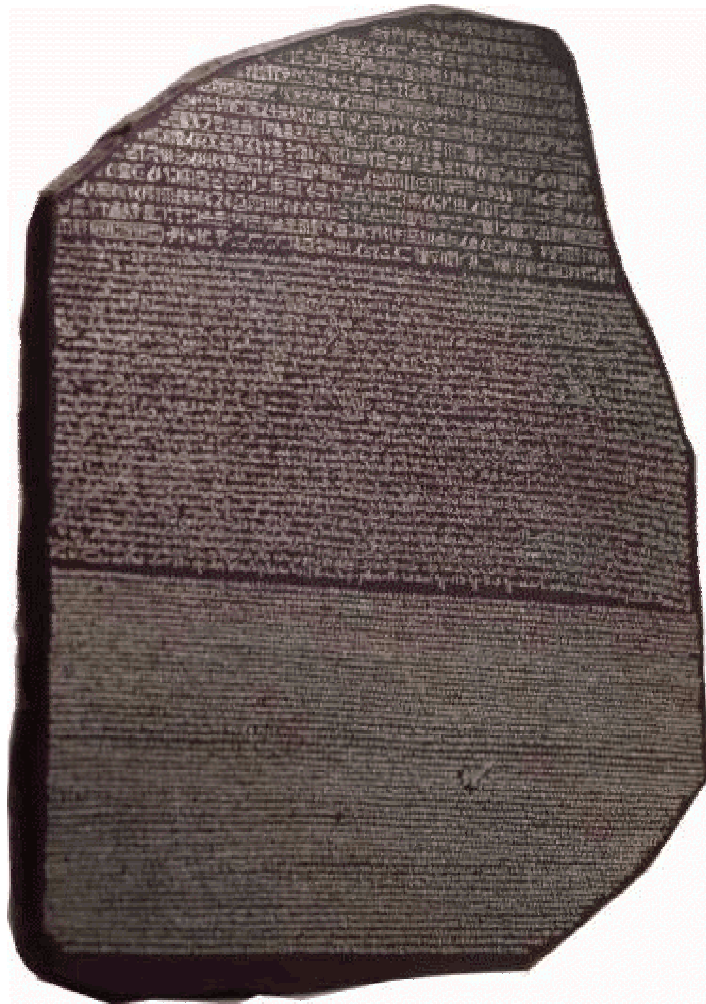

RosettaNet was founded in 1998 as non-profit consortium, to develop and promote business standards building global supply-chains in the CCE (Computer & Consumer Electronics), EC (Electronics Components), SM (Semiconductor Manufacturing), LG (Logistics), TC (Telecommunications) and SP (Solution Provider) industries.

RosettaNet Japan was founded in April, 2000, as a solely affiliates organization.

Mission: RosettaNet drives **collaborative** development and rapid **deployment** of Internet-based business standards, creating a **common language** and **open processes** that provide measurable benefits and are vital to the evolution of the **global** trading network.

Supply Chain Management

Collaboration with supply chain by RosettaNet standards

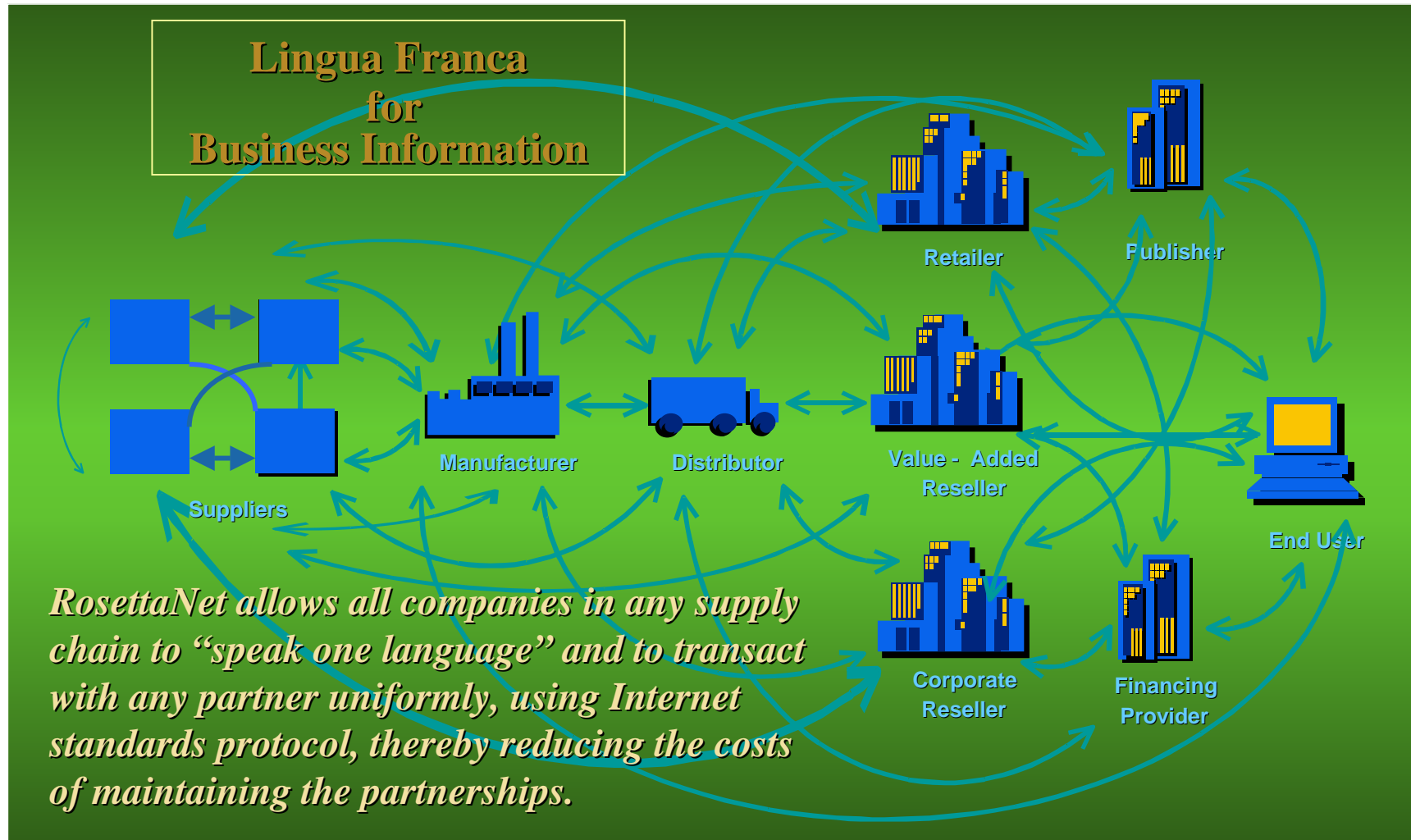

The expansion of RosettaNet World

B2B Global Standards

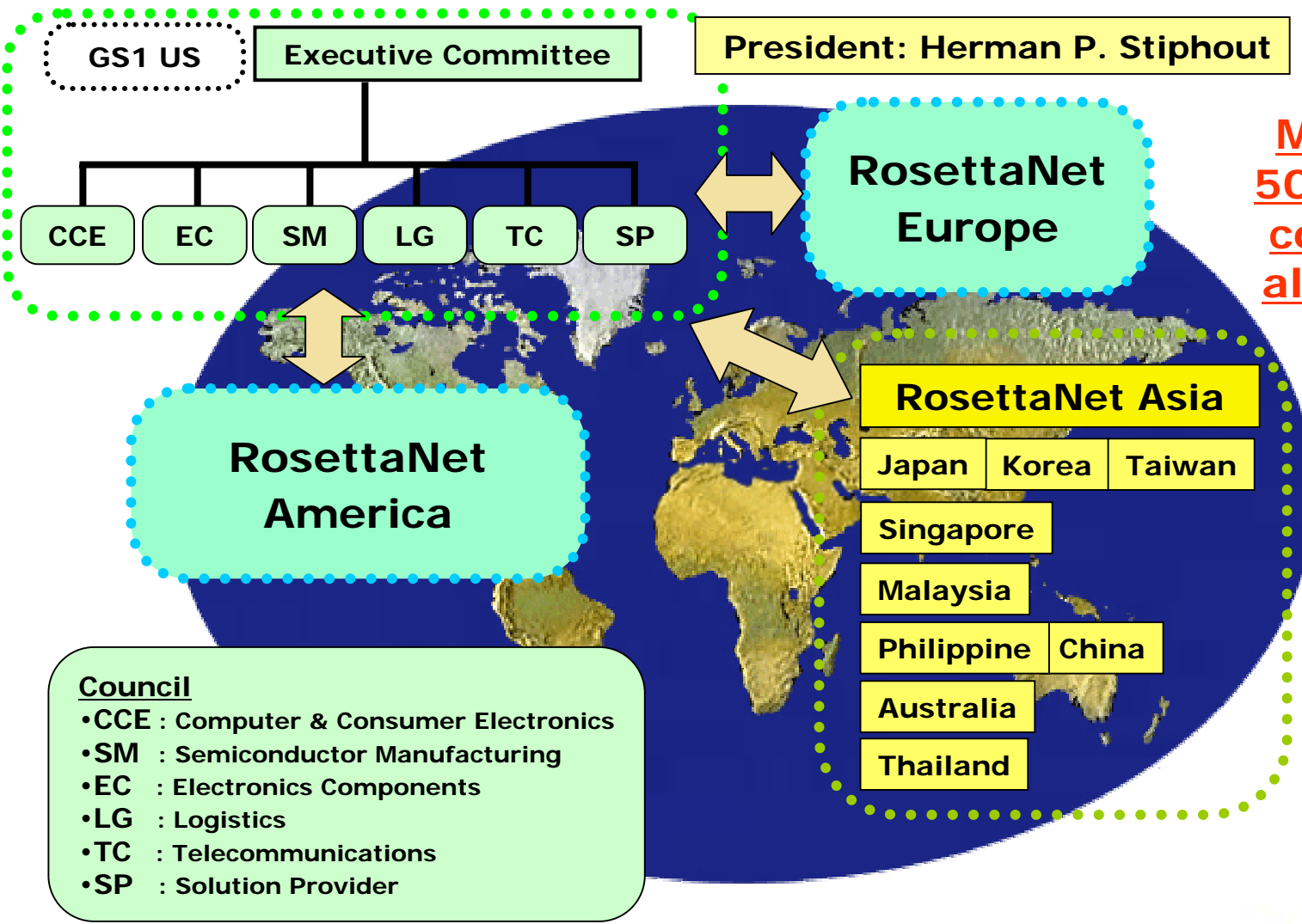

More than 500 member companies all over the world

- Council**
- CCE : Computer & Consumer Electronics
 - SM : Semiconductor Manufacturing
 - EC : Electronics Components
 - LG : Logistics
 - TC : Telecommunications
 - SP : Solution Provider

RosettaNet Global Connection Results

2001-2004

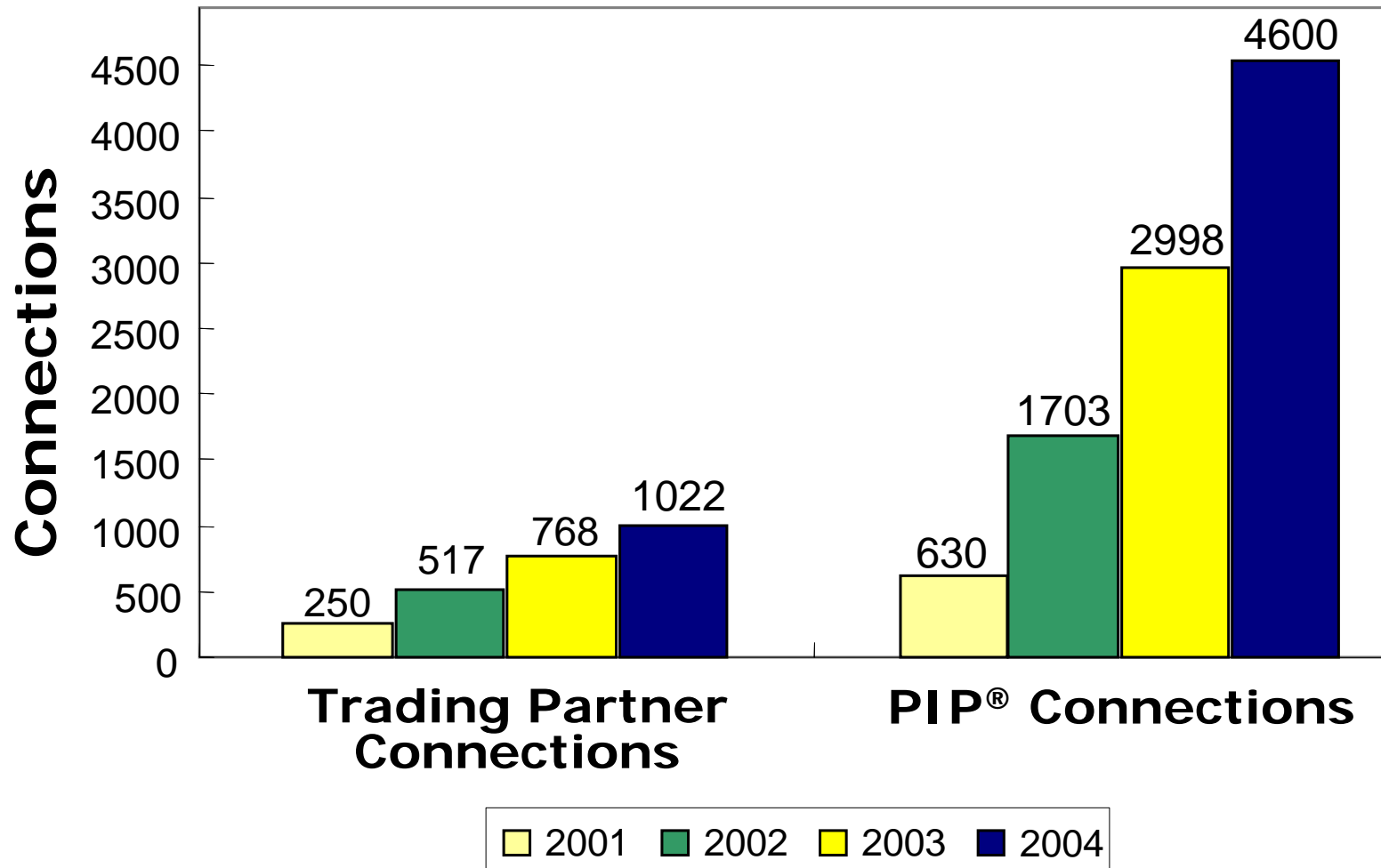

PIP®: Partner Interface Process®



What are RosettaNet standards?

Defining the technology & business processes under the support of RosettaNet standards

- **RNBD/RNTD (RosettaNet Business Dictionary & Technical Dictionary)**
 - Sets of semantics for assembling message for product information and business information
- **PIP[®] (Partner Interface Process[®])**
 - Definitions of message syntax and workflow for exchanging messages
- **RNIF (RosettaNet Implementation Framework)**
 - Definitions of technical requirements for enabling communication over the Internet by means of standard communication protocols (HTTP, HTTPS), digital signatures and authentication.

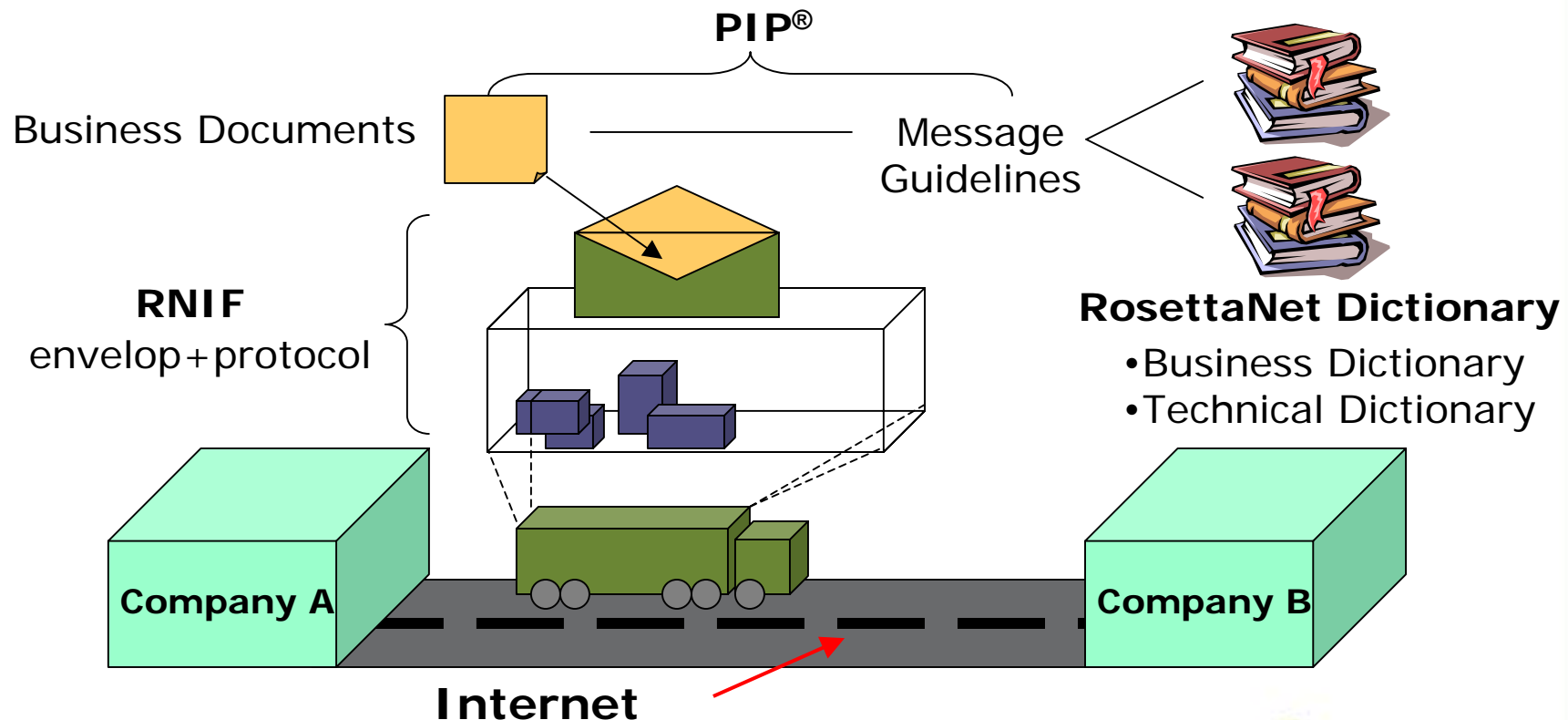

Agenda

Today's presentation

1. RosettaNet

2. Material Composition Milestone Program

3. Declaration Format

4. Activity of RosettaNet Japan (RNJ)

- ELCI (Environmental Life Cycle Information) -WG
- EIM (Engineering Information Management) -WG

5. Summary

RosettaNet Milestone Programs

eBusiness Process Alignment

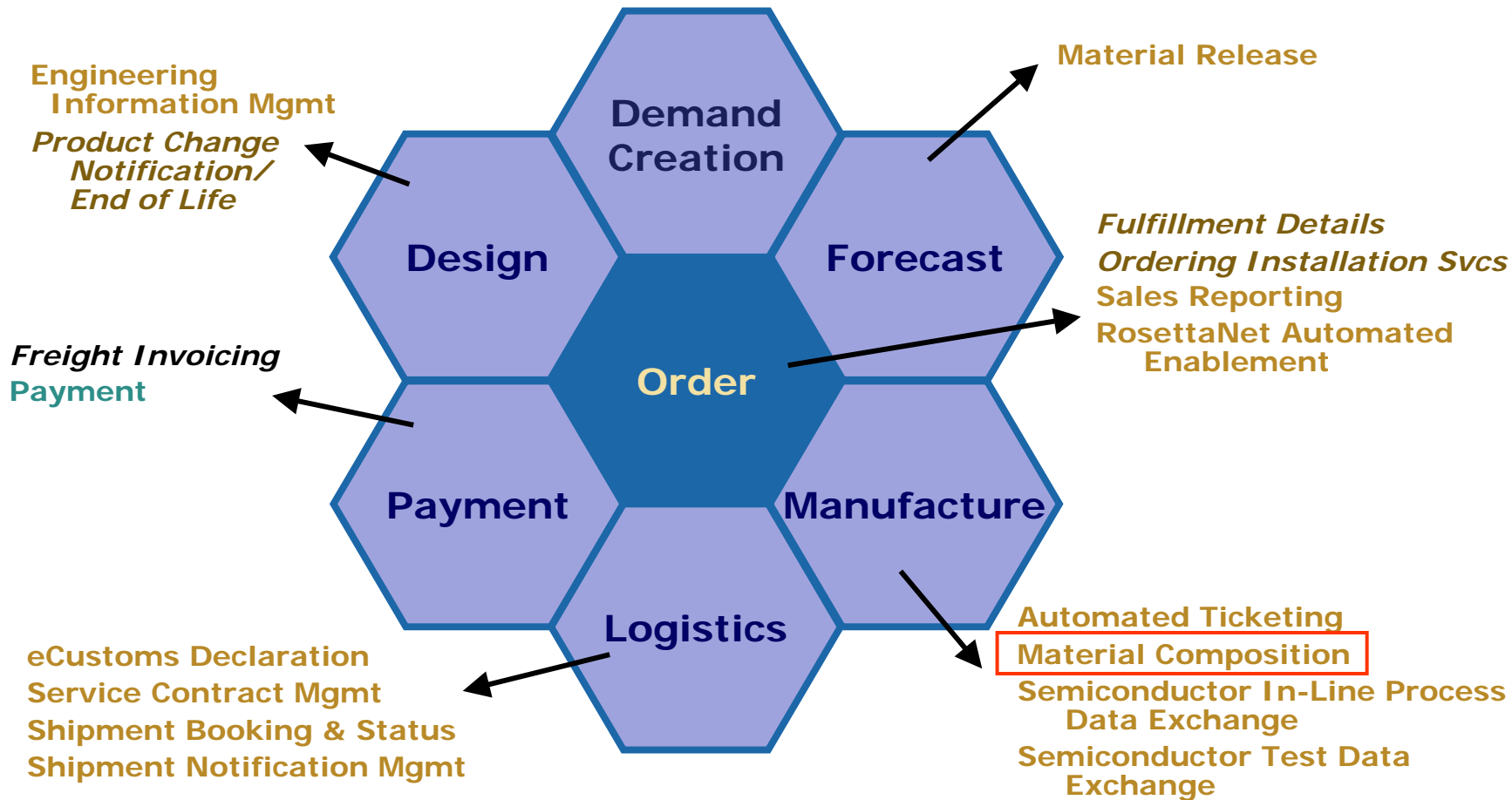

Program Status
Proposal
Forming
Active
Complete

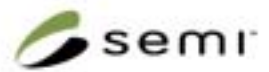

Material Composition

RosettaNet Milestone Program

OVERVIEW

Material composition e-business process allows companies to exchange material composition between supplier and customer. The idea is to include material composition information into other product information exchange. Main reasons to collect material composition information are upcoming legal requirements and increasing market requirements.

VALUE PROPOSITION

In response to government regulations and emerging customer expectations, the high-technology supply chain can streamline the exchange of material composition and related information through a standardized and automated global process.

MILESTONE

- Early implementation and validation with at least 6 connections by Q1/2005
- Production implementation by program partners with at least 14 additional connections by July/2005.



Material Composition e-Business Process

Redesigned Gathering Method

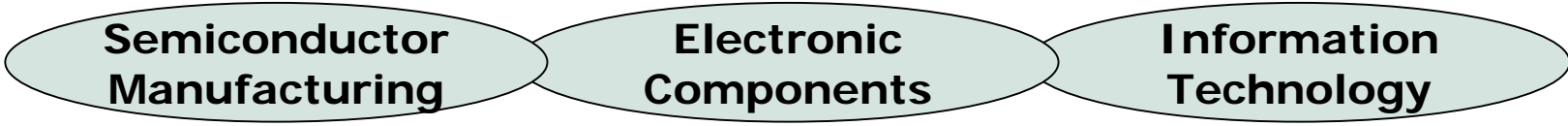

Important materials and substances and attributes identified.

Suppliers proactively send material composition information.

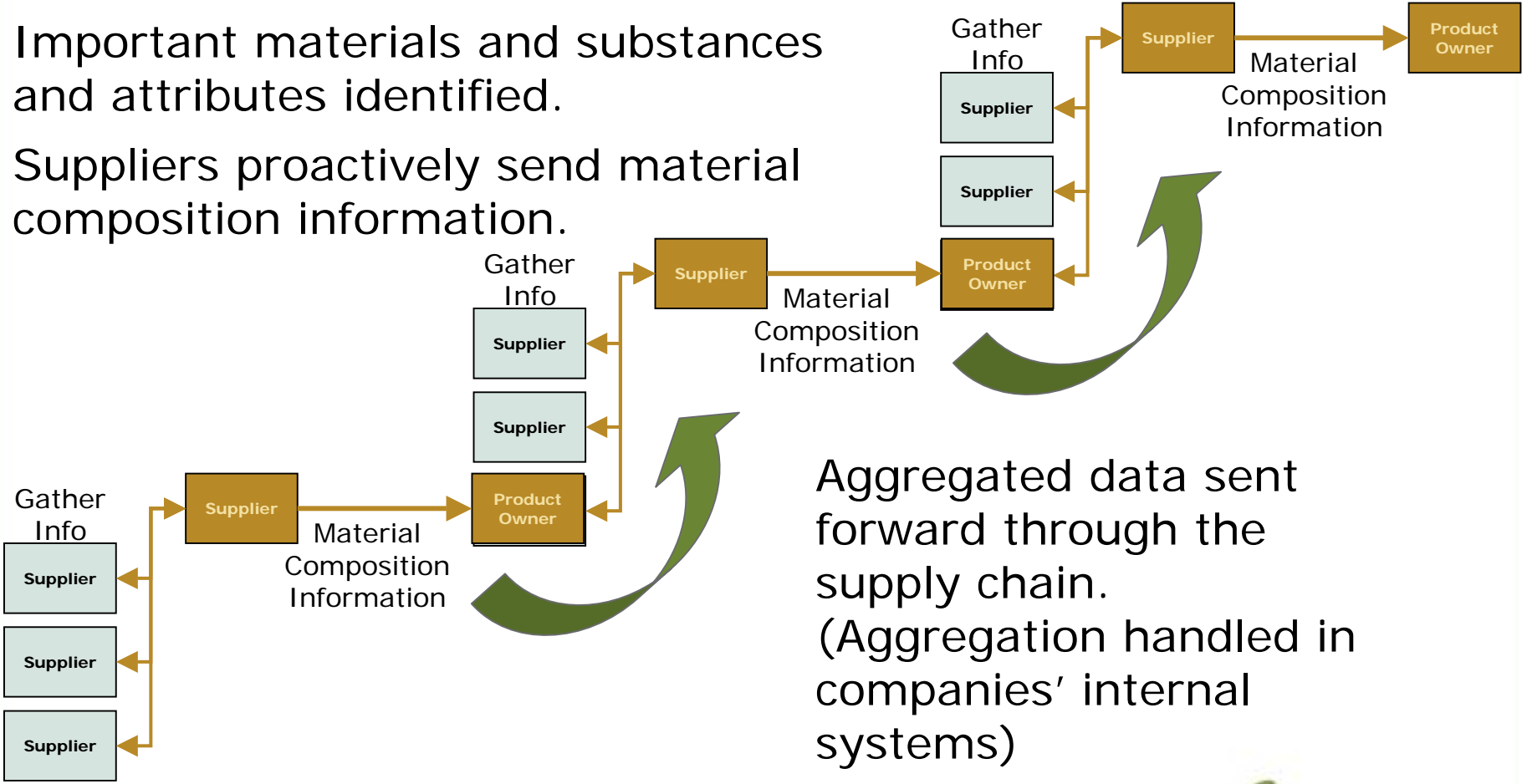

Aggregated data sent forward through the supply chain. (Aggregation handled in companies' internal systems)

Material Composition Data Model

Requirements by Material Composition Milestone Program

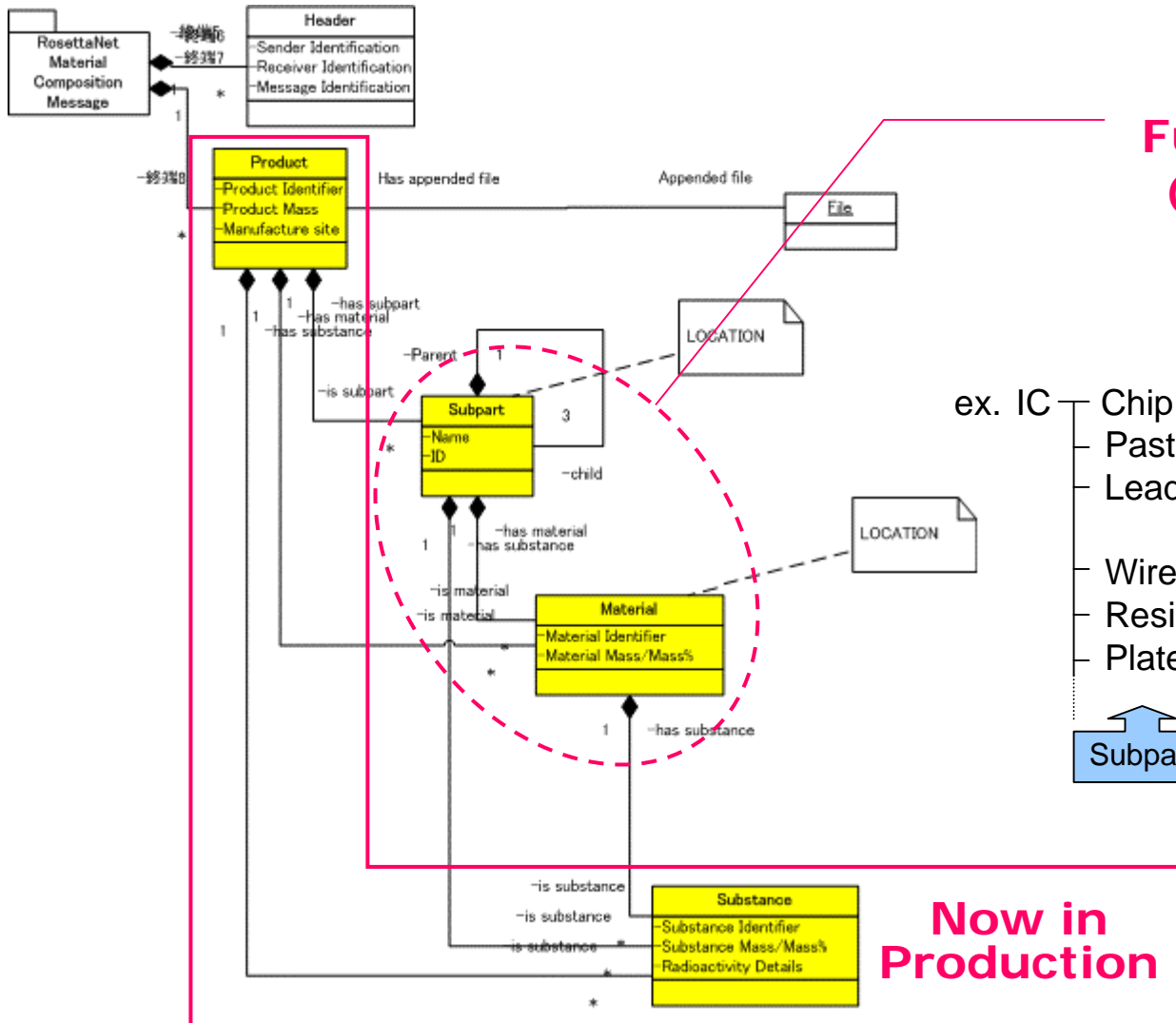

Future Scope: BOM (Bill Of Material)

- ex. IC
- Chip
 - Paste
 - Lead Frame — 42Alloy — { Fe, Ni }
 - Wire
 - Resin
 - Plate
- Subpart

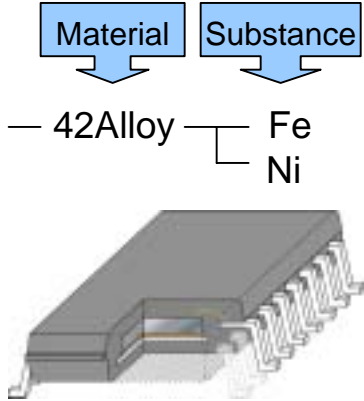

Now in Production



Material Composition Definitions in RNTD

RNTD contents based on Industry Standards

Annex A	Annex B
Asbestos	Antimony/Antimony Compounds
Azo colorants	Arsenic/Arsenic Compounds
Cadmium /Cadmium Compounds	Beryllium/Beryllium Compounds
Hexavalent Chromium/Hexavalent Chromium Compounds	Bismuth/ Bismuth Compounds
Lead/Lead Compounds	Brominated Flame Retardants (other than PBBs or PBDEs)
Mercury/Mercury Compounds	Copper/Copper Compounds
Ozone Depleting Substances (CFCs, HCFCs, HBFCs, carbon tetrachloride, etc.)	Gold/Gold Compounds
Polybrominated Biphenyls (PBBs)	Magnesium
Polybrominated Diphenylethers (PBDEs)	Nickel/Nickel Compounds
Polychlorinated Biphenyls (PCBs)	Palladium/Palladium Compounds
Polychlorinated Naphthalenes (more than 3 chlorine atoms)	Phthalates
Radioactive Substances	Selenium/Selenium Compounds
Shortchain Chlorinated Paraffins	Silver/Silver Compounds
Tributyl Tin (TBT) and Triphenyl Tin (TPT)	Vinyl Chloride Polymer (PVC)
Tributyl Tin Oxide (TBTO)	

- Contents based on JIG (Joint Industry Guide)
- Defines every substance by related code
- 24(+5) Material/Substance Categories, 400 Substances

Preferred Name	Short Definition	Formula	Long Definition	Remarks
Cadmium/Cadmium Compounds	The group of metals with cadmium as an element		The substance with the following CAS numbers:	Including the following:
		Cd	7440-43-9	Cadmium
		CdO	1306-19-0	Cadmium oxide
		CdS	1306-23-6	Cadmium sulfide
		CdCl ₂	10108-64-2	Cadmium chloride
		CdSO ₄	10124-36-4	Cadmium sulfate
		-----	9999-99-9	Miscellaneous

→ RJT031-001
 → RJT032-001
 → RJT033-001
 → RJT034-001
 → RJT035-001
 → RJT382-001

} RJP015-001

Sending Data using RosettaNet

Case: Supplier owning a B2B Server

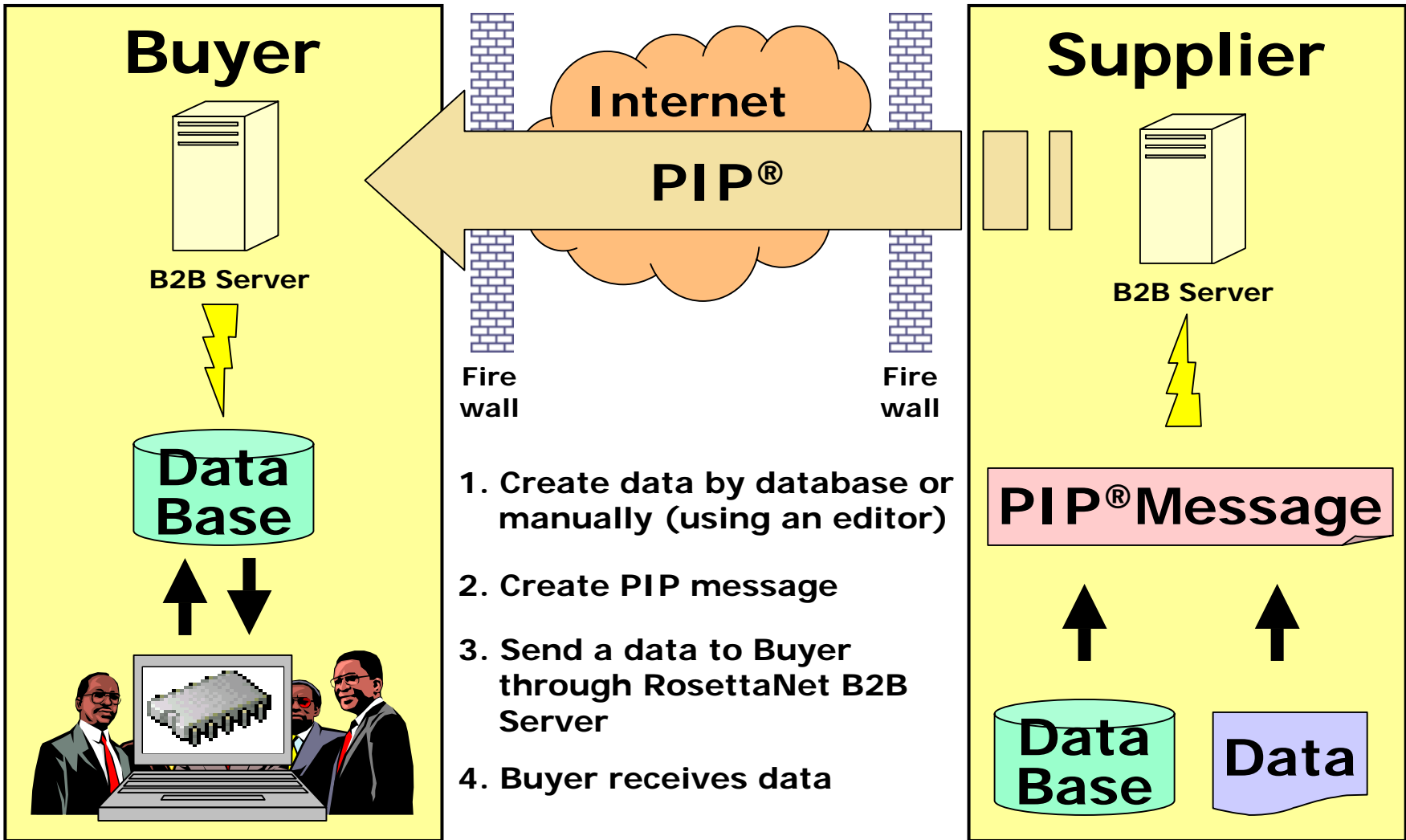

PIP[®]: Partner Interface Process[®]



Interoperability Festa

12, Nov. 2003 in Tokyo



Copyright 2003 Sony EMCS Corporation

Interoperability Festa

From one backend system to another backend system

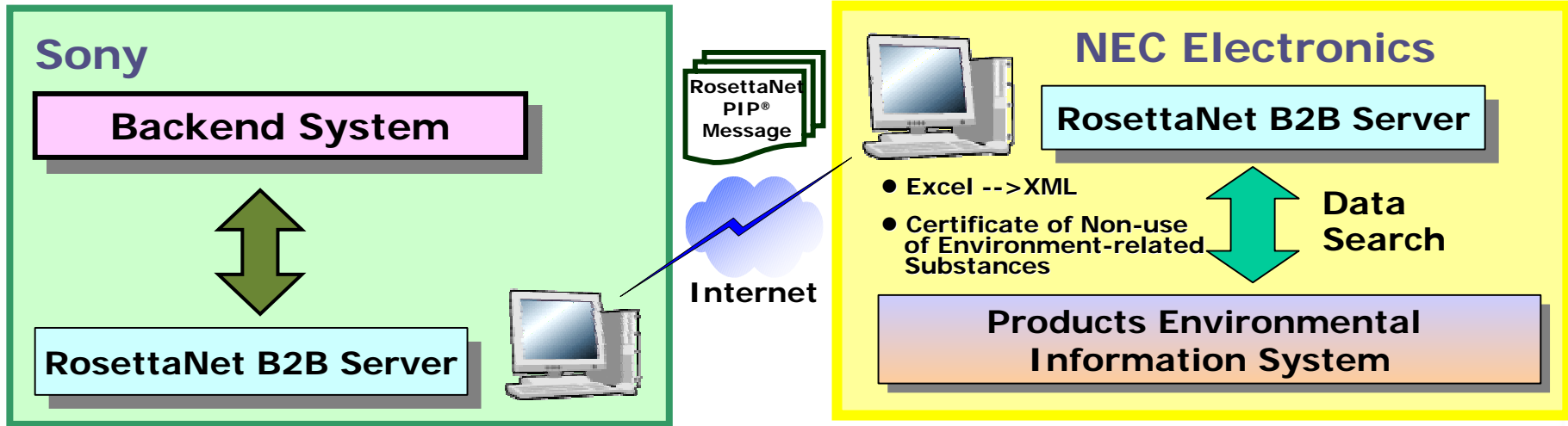

3-1-4 Part-Data Referral

Doc No.	Q/M Part Code	Device Code				
0001						
Header	Local Vendor Code	Supplier Name	Device Name	Name of the Contact Person	Telephone Number	
	0001	ROSETTA NETWORK				
Foot	Part Name	Part Description	QTY Number	Part Image		
	0001	QTY: 0001	0001			
Part	Classification of the Data	Date of EIP-301 File Submission	Approval CSMP Management	Date of Client Order Control	Reasons/Comments of Part/Article	Stop Date of Client Shipping/Advance
	# OE	# SO	# OE	# OE	# OE	# OE
	# SO	# SO	# SO	# SO	# SO	# SO
	# Not Investigated	# Not Investigated	# Not Investigated	# Not Investigated	# Not Investigated	# Not Investigated
	# Description	# Description	# Description	# Description	# Description	# Description
	Name of Client Supplier		Supplier PO Code	Original Order No.	Name of CSMP Approval	
# OE	# SO	# OE	# OE	# OE	# OE	# OE
# Outlines		# CSMP/ACT/OT	# Test/Date/Info	# CSMP-7	# Description	# Description
Reference Group No.	Reference Group Name	Contracting	Application	Pre-approval Date	Re-Approval Deadline	

Products' Environmental Information (Database) System

Internal Database Product data

Search

Search Product
Search PNG data
Product list by PNG

Product name	LPD8924G	PKG ID	19110		
Total weight(g)	0.220000	PKG Name	300ml SOP 16		
Parts	Parts weight(g)	Substance name	CAS No.	Content(g)	Concentr.
Chip (Die)	4.405	Arsenic	7440-36-2	0.004	
		Silicon	7440-21-3	4.399	
Bonding wires	0.330	Aluminum	7429-90-5	0.050	
		Gold	7440-57-5	0.330	
Lead frame	81.700	Copper	7440-50-8	60.400	
		Tin	7440-21-5	1.240	
		Nickel	7440-02-0	0.120	
			7440-	0.000	

PIP®: Partner Interface Process®

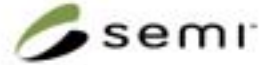

Agenda

Today's presentation

1. RosettaNet
2. Material Composition Milestone Program
3. Declaration Format
4. Activity of RosettaNet Japan (RNJ)
 - ELCI (Environmental Life Cycle Information) -WG
 - EIM (Engineering Information Management) -WG
5. Summary

Declaration Format

2 Formats that comply with JIG (Joint Industry Guide)

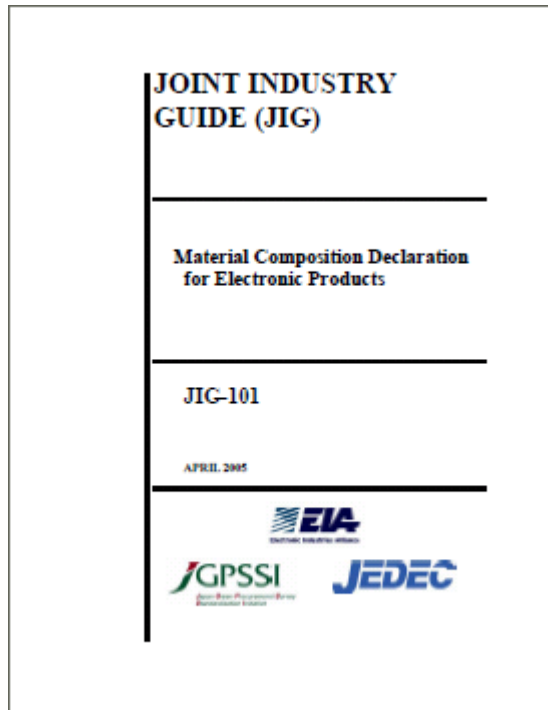

Released May 25, 2005

1) JGPSSI Format

- Developed by JGPSSI
- Excel Format
- Standard type and Detailed type
- Rolled Format compliant
 - > Only the Material/Substance Category in the products
- Version 2 already in use.
 - Currently changing the format to comply with the new JIG (To be released 12/2005)

2) IPC-1752

- Developed by iNEMI, IPC, RosettaNet
- PDF Format (Ver.7.0)
- Formatted by IPC-1752-1/1752-2
- Full Format compliant
 - > BOM Level description available
- To be released after review of ballot results (11/2005 ?)

JGPSSI: Japan Green Procurement Survey Standardization Initiative

IPC: Association Connecting Electronics Industries

iNEMI: International Electronics Manufacturing Initiative

Data utilization of IPC-1752

Export and Import of XML (PIP[®]) Data



The data can be exported to, as well as imported from, XML.
(IPC1752<-XML)

IPC-1752
(PDF)



XML
(PIP2A13)

Information Distribution using an ASP Service

Case: Supplier not owning a B2B Server

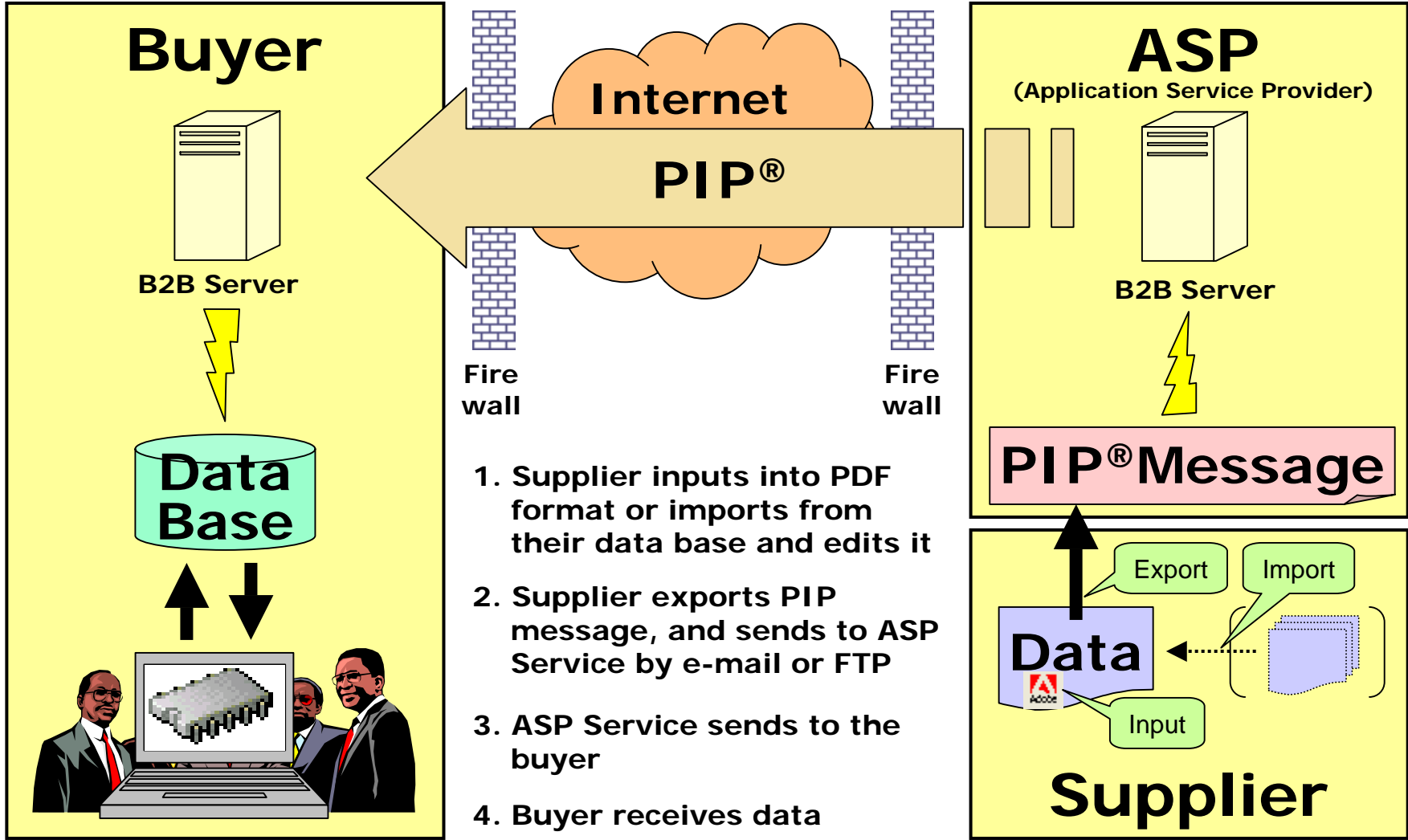

PIP[®]: Partner Interface Process[®]



Agenda

Today's presentation

1. RosettaNet

2. Material Composition Milestone Program

3. Declaration Format

4. Activity of RosettaNet Japan (RNJ)

- ELCI (Environmental Life Cycle Information) -WG
- EIM (Engineering Information Management) -WG

5. Summary

RosettaNet Japan Members List

Board & Partner Members

Board Company Name	
1	FUJITSU LIMITED
2	Hitachi,Ltd
3	Kyocera Corporation
4	Microsoft Co.,Ltd
5	NEC Corporation
6	Nihon Unisys Ltd.
7	NTT Communications Corporation
8	Otsuka Shokai Co.,Ltd.
9	ROHM CO.,LTD.
10	Sony Corporation
11	TOSHIBA CORPORATION
12	Renesas Technology Corp.

Coalition Partner	
1	Object Technology Institute, Inc
2	Japan Electric Measuring Instruments Manufacturers' Association(JEMIMA)

Partner Company Name	
1	ADDS Co.,LTD
2	ADVANTEST CORPORATION
3	ARGO 21 CORPORATOPN
4	BEA Systems Japan, Ltd
5	Cisco Systems, Inc.
6	DAI NIPPON PRINTING CO., LTD.
7	Data Applications Company. Limited
8	E2 Open Inc.
9	Electronic Devices Information Service Co., Inc
10	Freescale Semiconductor Japan Ltd.
11	Global eXchange Services Japan Corporation
12	Hewlett-Packard Japan, Ltd.
13	Ibiden Co., Ltd
14	Infoteria Corporation
15	Intec,Inc.
16	Intel K.K.
17	ITOCU TECHNO-SCIENCE Corporation
18	Japan Aviation Electronics Industry, Limited
19	JFE Systems, Inc
20	JSR Corporation
21	Justsystem Corporation
22	Kanematsu Electronics LTD.
23	Kintetsu World Express, Inc.
24	Matsushita Electric Co.,Ltd.
25	Mitsubishi Electric Corporation
26	Mitsui Knowledge Industry Co., Ltd.
27	Mizuho Corporate Bank, Limited
28	MOLEX JAPAN CO LTD
29	NEC Electronics Coporation
30	NEC Soft,Ltd.
31	NEC Tokin Corporation
32	NICHICON CORPORATION
33	NIPPON CHEMI-CON CORPORATION
34	Nippon Express Co., Ltd.
35	NIPPON TELEGRAPH AND TELEPHONE EAST CORPORATION
36	NS Solutions Corporation
37	NTT DATA CORPORATION
38	PFU Active Labs. Limited
39	PIONEER CORPORATION
40	Ryosan Company,Limited
41	Sanshin Electronics Co,LTD
42	Sanyo Electric Company Ltd.
43	SAP JAPAN Co.,Ltd
44	SEIKO EPSON CORPORATION
45	SHARP CORPORATION
46	SHINKO ELECTRIC INDUSTRIES CO.,LTD.
47	Shinko Shoji Co.,Ltd
48	SOFTBANK TECHNOLOGY CORP.
50	Sterling Commerce K.K.
51	STMicroelectronics K.K.
52	SUMITOMO BAKELITE CO.,LTD
53	Sumitomo Mitsui Banking Corporation
54	Sun Microsystems,Inc.
55	TAIYO YUDEN CO.LTD
56	Texas Instruments Ltd
57	Tokyo Ohka Kogyo Co., Ltd.
58	Toppan Printing Co.,Ltd.
59	TOSHIBA DOCUMENTS CORPORATION
60	Toshiba Logistics Corporation
61	Transcosmos inc.
62	Tsuken Advanced System co.
63	Tyco Electronics Corporation
64	UFJ Bank Limited

*as of Aug. 2005

RNJ Working Group relationship

Collaboration with related organizations

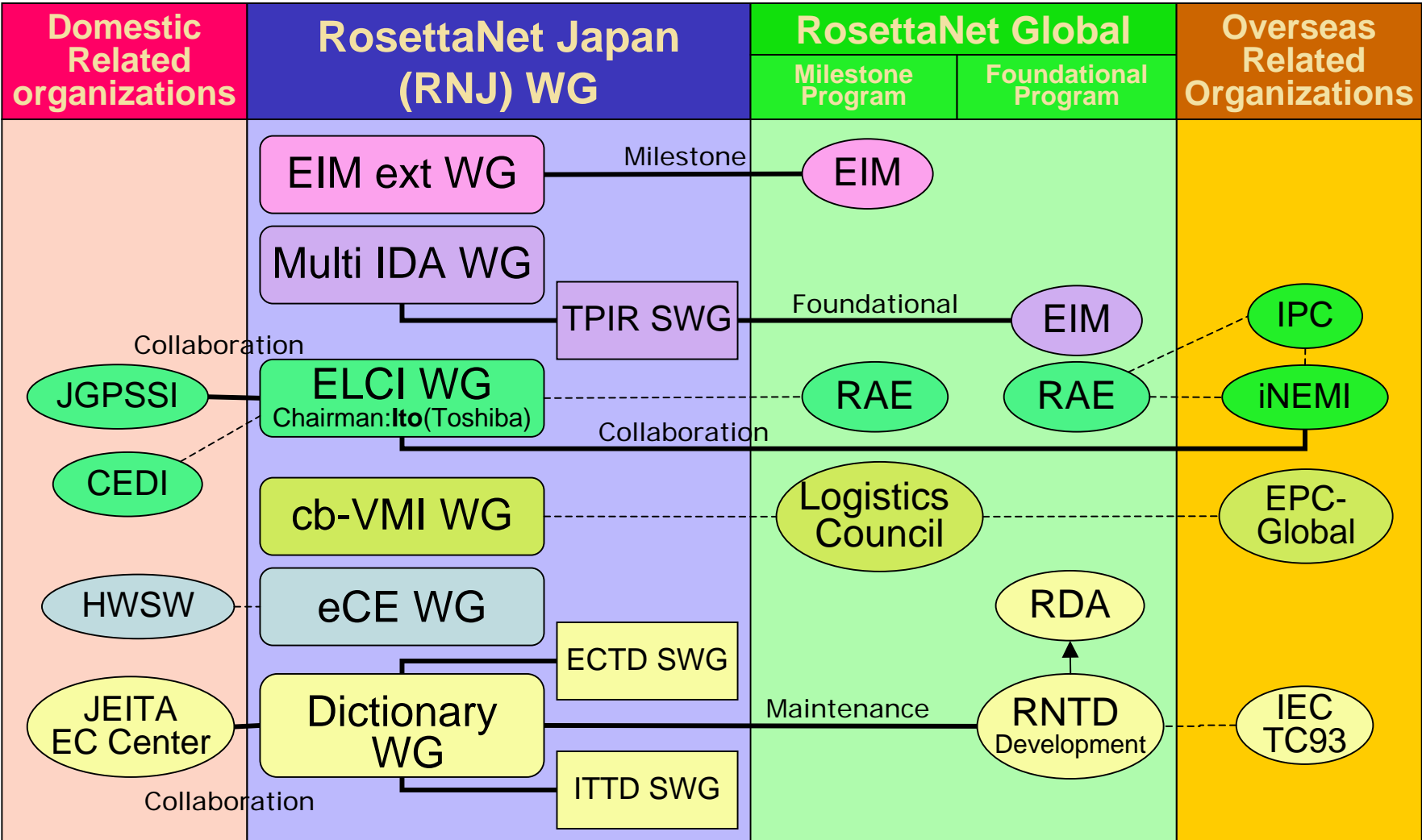

EIM: Engineering Information Management
 ELCI: Environmental Life Cycle Information
 eCE: e-Catalog Exchange

IDA: Information Distribution Agreement
 cb-VMI: cross board Vender Managed Inventory



Upstream to Downstream

Provide information through supply chain

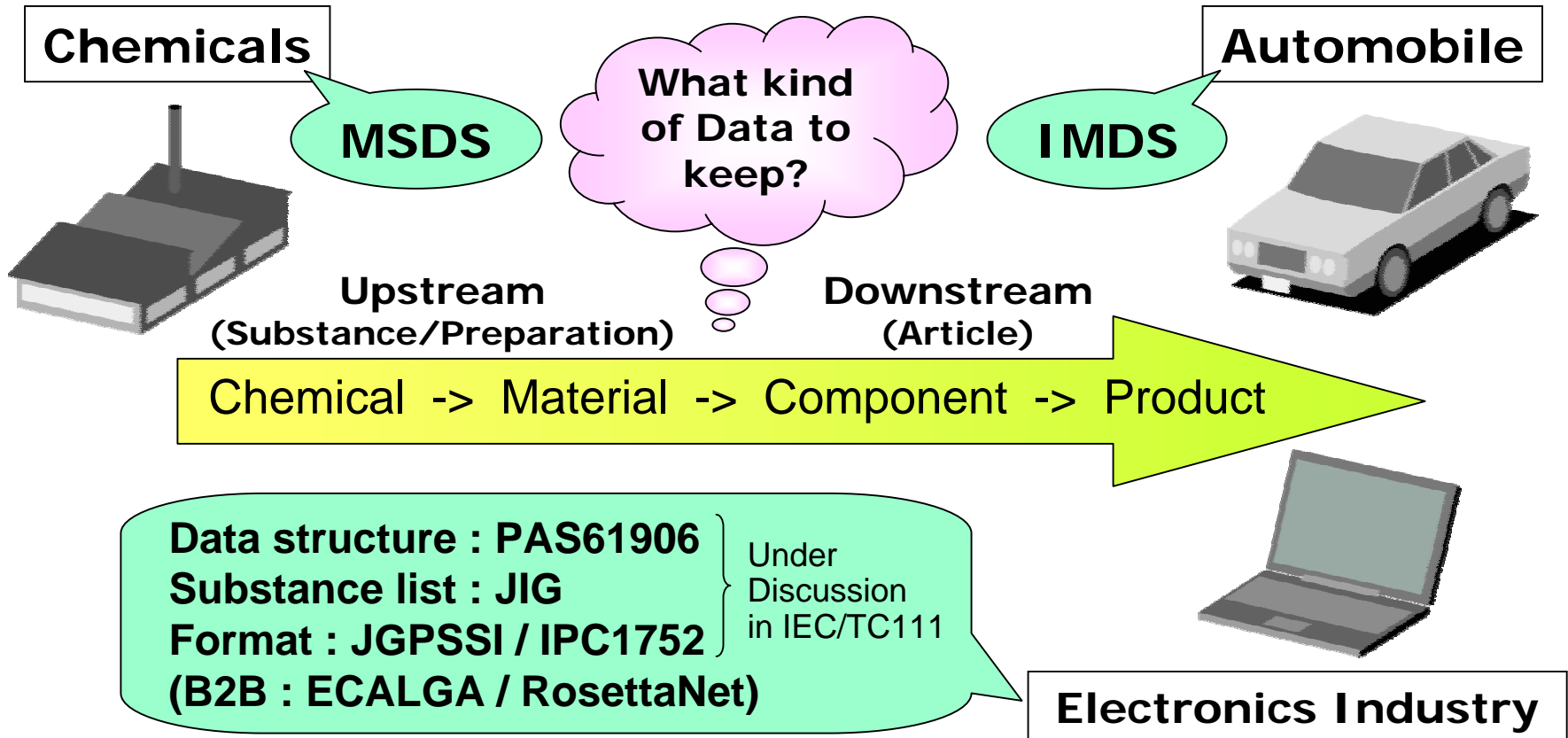

- Various ways of information gathering: No problem as long as the underlying data model is the same, but...
- What information is needed for eco-design?
 -> Need for further investigation.

Useful Environmental Information in RNJ Website

<http://www.rosettanet.gr.jp/bizPromotion/environment/index.html>



Compliance
 WEEE/RoHS, ELV, REACH, EuP, Packaging, Batteries, other
 Substance Investigations
 JIG, GADSL
 Related Organizations
 Reports and Presentations
 Data Mapping
 JIG-JGPSSI-RNTD Comparison Table
 RosettaNet Standards for Material Composition Reporting
 PIP, RosettaNet dictionary, RIG, reference documents
 Useful Links

コンプライアンス

- ▶ WEEE/RoHS
- ▶ ELV
- ▶ REACH
- ▶ EuP
- ▶ Packaging
- ▶ Batteries
- ▶ 総合

WEEE/RoHS

公布: 2003年1月
 施行: 2006年7月
 対象: 一般電気・電子機器・除外リストあり

内容の概略は指令(2)に示されていますが、対象と物質の関連、適用対象、除外対象などの詳細はTAC(技術規格委員会) (4)で審議進行中です。このためTACの動向や加盟国の詳細解説によって情報を補う必要が伴います。DTI(英国貿易産業省)のガイダンス(6)は関係者の多くが理解の助けになっている文書です。

No.	テーマ	資料内容/説明	言語	リンク
(1)	WEEE指令	2002/96/EC 原文	英	PDF
(2)	RoHS指令	2002/95/EC 原文	英	PDF
(3)	WEEE/RoHS指令	シートによる和訳	日	PDF
(4)	TAC情報	DTIによる非公式XtE	英	HTML
(5)	除外申請	インターネットコンサルテーション意見書	英	PDF
		除外申請評価レポート(ERA Doc. 2004)	英	PDF
(6)	ガイダンス	DTIによる英国向けガイダンス(2005年8月版)	英	PDF
		DTIによる英国向けガイダンス(2004年7月版)	英	PDF
		RosettaNet Japanによる和訳(2004年7月版)	日	PDF
(7)	FAQ	EUのWEEE/RoHS FAQ集	英	PDF
(8)	その他	RoHSエンブライアンス報告(EPA, 2004)	英	PDF
		シート0発行 ユーロトリング 2005年2月RoHS解説	日	HTML
		UK民間Website (Compliance Club)	日	HTML

●
●
●

EIM(Engineering Information Management)

Why is EIM activity needed?

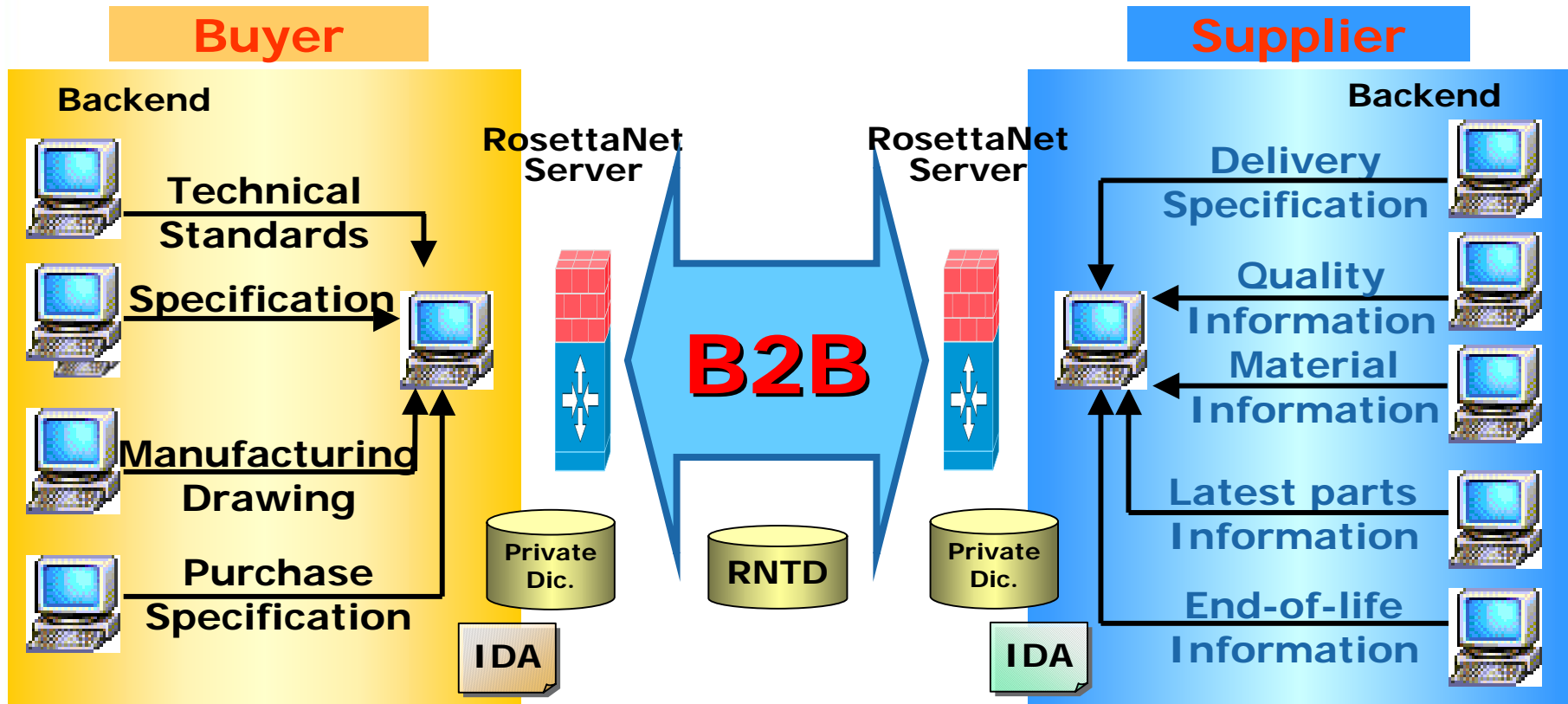

Buyers demand:

- The buyer wants reliable information data.
- The buyer wants the latest parts technical information from supplier.
- The buyer want to use information within whole company without any modification.

IDA: Information Distribution Agreement
RNTD: RosettaNet Technical Dictionary

Agenda

Today's presentation

1. RosettaNet
2. Material Composition Milestone Program
3. Declaration Format
4. Activity of RosettaNet Japan (RNJ)
 - ELCI (Environmental Life Cycle Information) -WG
 - EIM (Engineering Information Management) -WG
5. Summary

Summary

Information exchange through RosettaNet

- 1. Material Composition Information exchange is urgently needed in current business situation.**
- 2. RosettaNet is working on not only material information, but also on the EIM (Engineering Information Management) to be able to deal with all exchanges of technical information.**
- 3. RosettaNet is the one and only solution that can make it possible to exchange information through the entire supply chain.**
- 4. RosettaNet makes information exchange between business partners efficient.**

Thank you!



<http://www.rosettanet.org>
<http://www.rosettanet.gr.jp>

RosettaNet Japan
e-mail: rnj-contact@rosettanet.gr.jp
Tel: +81-3-5245-1079 Fax: +81-3-5245-7517